

MD240-2

Metal Loop Detector

Features

- Supply 240VAC
- Adjustable sensitivity (8 levels via a dip switch)
- 2 x Relay outputs (each can be configured individually)
- Power up and loop activation LED indicator.
- Industry standard 11-way plug-in type circular connector.
- Two loop detection function CH1 (10 way dip switch) and CH2 (7 way dip switch).



Application

- Controls automatic doors or gates when a vehicle is present source.

Description

Loop detectors in recent years have become a popular tool having innumerable applications in policing, right from surveillance operations to traffic control. Automation of gates and doors has become a popular usage of the loop detector.

The digital technology of the loop detector enables the equipment to sense a change in the inductance of the loop as soon as it detects the metal object in its path. The inductive loop which detects the object is made of insulated electrical wire (32/020; 32 Strand, 2mm diameter) and is arranged either as a square or rectangle shape.

The loop consists of several loops of wire and consideration should be giving to the loop sensitivity when installing on different surfaces. Setting the correct sensitivity allows the loop to operate with maximum detection (8 levels via a dip switch settings). Channel 1, is set by the 10 way dip switch and channel 2 is set by 7 way dip switch. When detection occurs, the detector energises 2 relays for the output (each can be configured individually). This energising of the relay can be configured into different modes, by selecting the respective dip switch.

Technical Data

Supply voltage	240VAC
Outputs	2 changeover relays rated at 240VAC, 3A
Connection	Screw type terminal

Connections

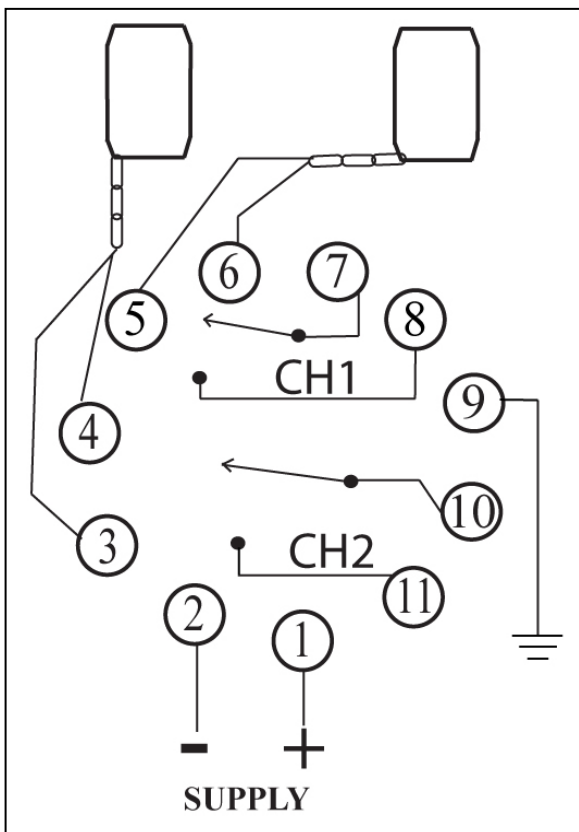

Pin	Type
1	240VAC
2	240VAC, Neutral
3	CH1 Loop
4	CH1 Loop
5	CH2 Loop
6	CH2 Loop
7	CH1 Dry Contact
8	CH1 Dry Contact
9	Earth
10	CH2 Dry Contact
11	CH2 Dry Contact

Both loops have to be connected in order for the MD240-2 to work.



Sensitivity Selection



Sensitivity and frequency of the loop can be adjusted by 7-way dip switch and 10-way dip switch setting. User can select 8 different setting by changing the setting of the dip-switch to different modes as in the dip-switch setting tables below. Dip switch 6, 7 and 8 for CH1 sensitivity selection with 0.8 being the least sensitive and 0.015 being the most sensitive. Dip switch 3, 4 and 5 for CH2 sensitivity selection with 0.8 being the least sensitive and 0.015 being the most sensitive.



Dipswitch Settings



Switch 1: Channel 1 Loop Function Selection (10 way dip switch)









Dip switch Settings 1 of CH1		Function
Special Sensitivity Increase For Both Trailer (Both Channels)		
Dip switch 1 is ON		Increase sensitivity for both channel to avoid unwilling relay Off for leaving especially for trailer



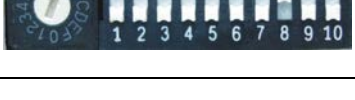

Dip switch Settings 1 and 2 of CH1		Function
<u>Automatic Reset (Both Channels)</u>		
Dip switch 2 is ON		Vehicle can be permanently present. (no auto-reset, unless vehicle has left or manual reset)
Dip switch 2 is OFF		Normal mode, (automatic reset after 10minutes present of vehicle, used to solve the mistake operation. If it is recommended).

Dip switch Settings 3 of CH1		Function
<u>Special Functions</u>		
Dip switch 3 is ON		Direction Detection. (If vehicle moves from CH1 to CH2, then CH1 relay output; if vehicle moves from CH2 to CH1, then CH2 relay output).
Dip switch 3 is OFF		Normal mode, two loop detection are separated.



Dip switch Settings 4 of CH1		Function
<u>Special Functions</u>		
Dip switch 4 is OFF		CH1 relay will be present output.
Dip switch 4 is ON		CH1 relay output type is pulse.



Dip switch Settings 5 of CH1		Function
<u>Special Functions</u>		
Dip switch 5 is OFF		When vehicle goes in, CH1 relay is in pulse output for 200ms.
Dip switch 5 is ON		When vehicle has left the loop, CH1 relay will delay 200ms and will give pulse output for 600ms.









Dip switch Settings 6, 7 and 8 of CH1		Sensitivity (%)
<u>Sensitivity Selection. (Eight Levels Choices)</u>		
Dip switch 6,7 and 8 is ON		0.015 (highest sensitivity range).
Dip switch 6 and 7 is ON		0.02
Dip switch 6 and 8 ON		0.04
Dip switch 6 is ON		0.08
Dip switch 7 and 8 is ON		0.12
Dip switch 7 is ON		0.2
Dip switch 8 is ON		0.5
Dip switch 6, 7 and 8 is OFF		0.8 (lowest sensitivity range)





Dip switch 9 and 10 of CH1		Frequency
Frequency (30 K to 100 KHz). Used to avoid the interference		
Dip switch 9 and 10 is OFF		High
Dip switch 9 is ON		Medium-High
Dip switch 10 is ON		Medium-Low
Dip switch 9 and 10 is ON		Low

Switch 2: Channel 2 Loop Function Selection (7 way dip switch)

Dip switch 1 of CH2		Function
Relay Output Type Selection		
Dip switch 1 is OFF		CH2 relay will be present output
Dip switch 1 is ON		CH2 relay output type is pulse

Dip switch 2 of CH2		Function
Relay Pulse Output Type Selection		
Dip switch 2 is OFF		When vehicle goes in, CH2 relay is in pulse output for 200ms
Dip switch 2 is ON		When vehicle has left the loop, CH2 relay will delay 200ms and will give pulse output for 600ms

Dip switch 3, 4 and 5 of CH2	Function	
<u>Sensitivity Selection</u>		
Dip switch 3, 4 and 5 is ON		0.015 (highest sensitivity range)
Dip switch 3 and 4 is ON		0.02
Dip switch 3 and 5 is ON		0.04
Dip switch 3 is ON		0.08
Dip switch 4 and 5 is ON		0.12
Dip switch 4 is ON		0.2
Dip switch 5 is ON		0.5
Dip switch 3, 4 and 5 is OFF		0.8 (lowest sensitivity range)

Dip switch 6 and 7 of CH2		Function
<u>Frequency Selection</u>		
Dip switch 6 and 7 is OFF		High
Dip switch 6 is ON		Medium-High
Dip switch 7 is ON		Medium-Low
Dip switch 6 and 7 is ON		Low

Setup Instructions

Power Led

RED power LED indicates “Power ON”

Detecting Led

Continuously On: Indicates vehicle detection.

Blinking slowly: Indicates loop is short circuit or the number of twists after the loop is not enough.

Blinking fast: Indicates loop is open circuit or too many twists after the loop.

Power : Red Led		If it is fully lit, power is supplied.
Green Led	CH1	If it is fully lit, a vehicle is detected on loop 1. If it blinks, then loop 1 is faulty.
	CH2	If it is fully lit, a vehicle is detected on loop 2. If it blinks, then loop 2 is faulty

Sensitivity Selection

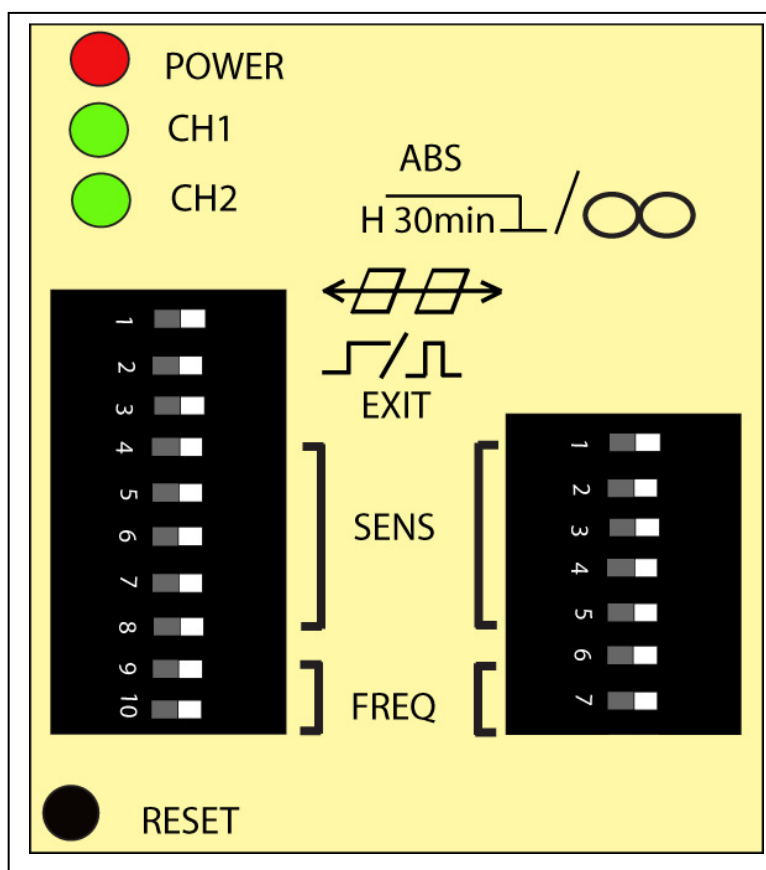

* In the application, where two or more loop detectors and sensing loops have been installed, set one detector to high frequency and the other set to low frequency to minimize the effects of cross-talk between the two systems (The sensing loops and detectors should be positioned at least 2m apart).

Reset Button: Please note: The MD240-2 must be reset every time a setting change is made to the Dip switches.

LOOP

Elsema stocks pre-made loops for easy installation. Our pre-made loops are suitable for all types of installations. Either for cut-in, concrete pour or direct hot asphalt overlay.

see www.elsema.com/auto/loopdetector.htm

Loop1200 : 1.2 x 1.2 metres -- 3 metres Lead-in plus 3 metres twisted wire.

Loop1500 : 1.5 x 0.8 metres -- 3 metres Lead-in plus 3 metres twisted wire.

Loop2000 : 2.0 x 1.2 metres -- 3 metres Lead-in plus 3 metres twisted wire.

We can also make custom size loops. Please contact us for your custom loop size.

Detector position and installation

- Install the detector in a weatherproof housing.
- The detector should be as close to the sensing loop as possible.
- The detector should always be installed away from strong magnetic fields.
- Avoid running high voltage wires near the loop detectors.
- Do not install the detector on vibrating objects.
- When the control box is installed within 10 metres of the loop, normal wires can be used to connect the control box to the loop. More than 10 metres requires the use of a 2 core shielded cable. Do not exceed 30 metres distance between control box and loop.

Troubleshooting

Symptoms		Solution
If the detector is not working		Press reset
If red led indicator is not fully lit		Check for power supply
If green led indicator:	Blinks slowly	It maybe because the loop is short circuit or the no: of turns is not enough.
	Blinks faster	It maybe because the loop is open or the no: of turns is too many.
If no: of turns is not enough		Lower the frequency (if the frequency is still too high, you must add more turns).
If no: of turns is too many		Higher the frequency (if the frequency is still too low, you must remove some turns).

Manufactured by

Elsema Pty Ltd
 31 Tarlington Place, Smithfield
 NSW 2164, Australia
 Ph: 02 9609 4668
 Fax: 02 9725 2663
 Website: <http://www.elsema.com>

Distributed by

--